



HOW TO MAKE YOUR OWN ARCHERY EQUIPMENT

Contents:

How to:

1.	Make your own bow handle (riser).	Page 3
2.	Make your own bow limbs.	Page 6
3.	Make your own string.	Page 10
4.	Make your own bow stringer.	Page 19
5.	Make your own sight.	Page 20
6.	Make your own arrow rest.	Page 22
7.	Make your own pressure button.	Page 28
8.	Make your own draw length checker (clicker).	Page 29
9.	Make your own arrow shafts.	Page 30
10.	Make your own fletchings.	Page 34
11.	Make your own finger protector (tab).	Page 37
12.	Make your own arm guard (bracer).	Page 39
13.	Make your own finger sling.	Page 40
14.	Make your own quiver.	Page 45
15.	Make your own ground quiver.	Page 47
16.	Make your own target.	Page 48
17.	Make your own target stand.	Page 50
18.	Make your own bow stand.	Page 52
19.	Make your own arrow container.	Page 55

1. How to make your own bow riser (bow body / handle):

Necessary materials for making the riser:

- a model or pattern,
- a medium-sized saw,
- a small saw,
- a saw blade,
- a wood plane,
- a spoke shave,
- a cooper tool,
- a hammer,
- a rasp,
- a flat file,
- a rough triangular file,
- a bow square or set square,
- a measuring tape,
- a "bar clamp" or "G clamp",
- a ruler,
- pincers or pliers,
- aluminium or other material in the form of an U (with a length of 7 cm, a width of 4 cm, a height of 2 cm and a thickness of 1 mm)
- a plate made of aluminium or another material with a length of 12 cm to 14 cm, a width of 4 cm and a thickness of 1 mm.
- a pencil,
- an eraser,
- nylon thread,
- sand paper,
- a machete or a hand axe,
- use 2 to 3 years old dried large bamboo sticks (thickness = 1.5 to 2 cm, length: 1.5 m).

NB: Cut the bamboo near the earth's surface during waning moon and dry it for at least 45 days.

Cut out a plank of mahogany, teak or another hard wood with a length of 50 cm, a height of 11 cm and a thickness of 4 cm.

Making the riser:

Cutting out the shape of the riser;

1. Draw the form of the riser on the plank of mahogany by means of the pattern; see illustrations 1.1, 1.2 and 1.3.

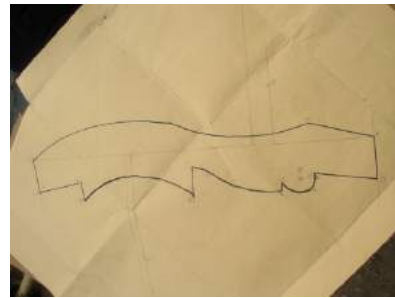

Illustration 1.1



Illustration 1.2

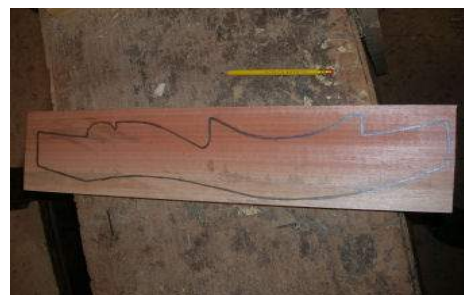

Illustration 1.3

2. Use the "bar clamp" or "G clamp" to fix the plank to a bench so that the drawn shape can be cut out.
3. Saw out the shape of the riser. See illustrations 1.4 & 1.5.



Illustration 1.4



Illustration 1.5

4. At this stage cut out a sight window in the upper part of the riser (to the left for right-handed archers and to the right for left-handed archers).

How to make the sight window for a left-handed archer:

You have to cut out the sight window to the right, which means that you have to hold the riser with your right hand.

Draw a line on the curved piece of the now roughly shaped "riser" at a distance of 2cm to the upper edge of the protruding corner and another line at a distance of 2cm to the lower edge. Draw a longitudinal line which divides the space of 4cm into two equal pieces; see illustrations 1.6, 1.7 and 1.8.



Illustration 1.6



Illustration 1.7



Illustration 1.8

Cut out the sight window following the lines on the right side of the riser. The riser is fragile near the protruding corners and is likely to break or chip if care is not taken, see illustration 1.9.



Illustration 1.9

Round off the upper and lower ends of the sight window. These curves do not weaken the riser too much. The upper curve can be a bit "larger" than the lower curve. Here you can see an example of form which is a good compromise for the edge of the sight window while maintaining the strength of the riser see, illustration 1.10. Take the sand paper and polish the whole riser.

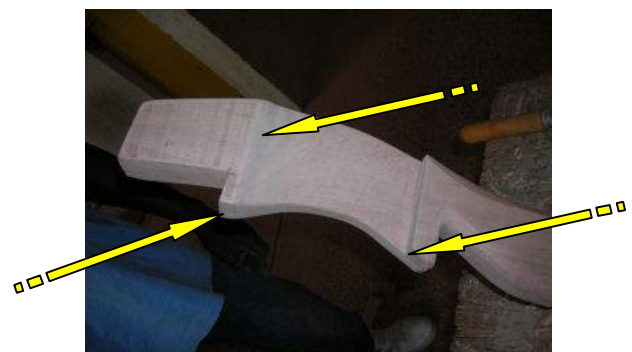

Illustration 1.10

There is two ways of making the fixing for the limbs. One way is to bend a piece of the metal into a channel and screw it to the riser as shown in illustration 1.11, or the metal can be shaped into a channel and fixed to the riser as shown in illustration 1.12.



Illustration 1.11



Illustration 1.12

~~~~~ 0 0 ~~~~~



## 2. How to make your own bow limbs:

### Material needed:

- mallet or hammer,
- wide chisel,
- measuring tape,
- saw,
- plane or draw knife,
- flat rasp or file,
- small round file,
- well seasoned bamboo, 80 cm long.

### Using bamboo:

#### Which bamboo to choose?

Use mature bamboo between 2 and 3 years of age. You can get an estimation of the age from the yellowish colour and from the sound when you hit the bamboo with a piece of wood or iron.

#### How to cut the bamboo:

Select the bamboo that has a large diameter and a wall thickness of between 4 and 6 millimetres. Cut the bamboo low down near the earth's surface and cut the trunk into lengths of 80 centimetres.

#### Drying:

Dry the bamboo for at least 45 days before using it.

#### How to determine the length of the limbs:

The length of the bow made from bamboo corresponds to the size of the archer.

In the following example, we have taken the archer to be approximately 170 cm tall. The riser should have a length of approximately 50 cm. And the length of each limb should be approximately 71 cm.

The overlapping zones between riser and limbs for fixing the limbs on the riser should be 9 cm on each side. The string nock has to measure 1.5 cm. from the end of the limb.

### Presentation of the aluminium parts for fixing the limbs.

#### Guide of the limbs:

The guides are made of aluminium box section bars (length: 6 cm, width: 4 cm and height: 1 mm) which are available in stores. Cut them into two pieces lengthwise and you

get several "U"s with 7 cm length, 4 cm width and 1.6 cm height, see illustration 2.1.



Illustration 2.1

#### Braces of the limbs:

For the braces of the limbs see illustrations 2.2 and 2.3. You have to choose between two alternatives:

- a. You can use the remains of your bar which you used for making the guides of the limbs. For this, open the angles and you get panels with a length of 12 to 14 cm while the width and height remain the same, see illustration 2.2.
- b. Cut out pieces of 12 to 14 cm long from the panel made of aluminium or a similar material. The limbs will be put into the guides that are fixed to each end of the riser. Fix the aluminium panels in the form of a "U" with tacks 2 cm long to the two ends of the riser. Each end is 9 cm long and 4 cm in width and has a guide with a length of 7 cm and a width of 4 cm with a height of 1.6 cm see illustration 2.3.



Illustration 2.2



Illustration 2.3

#### Cutting the bamboo to size:

Split the bamboo into two pieces by means of a blade or a hand axe or wood chisel by paying attention to the direction of the bamboo fibres. Do not use a saw as this will possibly not run true with the fibres, see illustration 2.4.



Illustration 2.4

If the diameter of the bamboo is large enough, it may be divided into four or six pieces with a width of 4 cm for each limb. The inner knots should be removed as these will affect the curvature of the limb, see illustration 2.5.



Illustration 2.5

#### Assembling the limbs:

Put the bamboo on the guide that is in the form of a "U" on the riser, and mark the excessive material with the pencil. The excessive material has to be removed in order for the limbs to fit into the "U" guide, see illustration 2.6.



Illustration 2.6

Remove the excessive material to a length of 7 cm using wood plane or wood chisel and fix the bamboo "limb" into the "U" section on the riser.

**NB:** Even if you turn the riser upside down, the inserted limbs must not slip off the "U" guide.

Find the central alignment by tying a nylon thread to the centre of each limb tip, and using this as a guide, draw on the bamboo the shape you want the limb to be, see illustration 2.7.



Illustration 2.7

Then take the "limbs" off the riser and remove the excess wood that is outside the lines drawn, see illustration 2.8.



Illustration 2.8

When the rough shape is achieved either a spoke shave, rasp or wood plane can be used to finally shape the "limbs", see illustrations 2.9 and 2.10.



Illustration 2.9



Illustration 2.10

Forming the groove on the end of the limbs to take the string end:

Finally shape the ends of the limbs and draw a line across the limb 2 cm away from the end of the limb on the side which is visible to the archer when in the shooting position, and another 1.7 cm from the end of the limb on the side which is not visible to the archer in shooting position. For determining the form of the future string nock, draw a mark at a distance of 5 mm of each side of the centre line. This necking carries the string loop. The necking (shaping) must be sloping, see illustration 2.11.



Illustration 2.11



Cut out the shape of the limb tip with a saw or a saw blade, see illustration 2.12.



Illustration 2.12

Then finish your work by smoothing the limb tip with a small round file, see illustration 2.13. Ensure that this area is not left with any sharp corners as this will cut the bow string.



Illustration 2.13

When the riser and limbs are fitted together and the string is fitted you will have a bow, as can be seen in illustration 2.14.



Illustration 2.14

Note: For a while occasionally look at the string ends to ascertain that no wear is appearing on the serving at the loop ends of the string. If any wear does appear remove the string and remove any sharp areas on the limb tips where the string is fitted.

~~~~~ 0 0 ~~~~~

3. How to make your own string:

Materials needed:

- a string jig as shown in illustration 3.1.
- a spool of Dacron.
- braided serving material.
- string serving tool.
- scissors.
- a ruler.
- 2 markers (each a different colour).

Dacron should be used for making a string for a beginner's bow; other materials could diminish the life of the string and the bow considerably. Whatever the material used, the basic method to make a string remains the same, but watch for the number of strands.

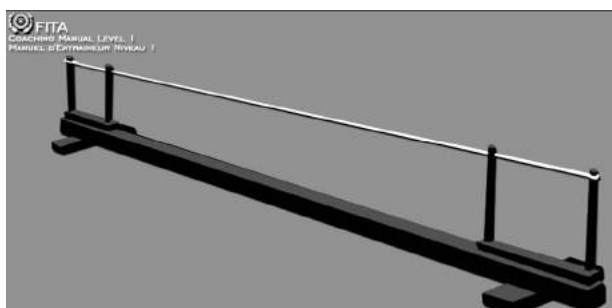

Illustration 3.1

Installation onto the string jig:

If you already have a bowstring to the length of the new one you are about to make it will be easier to make the new one to the correct length at the first attempt. If you do not already have a string which is of the correct length there are procedures and measurements which will help get close to the length of string required. This will be discussed a little later.

If you have a string that is the correct length:

Turn the string jig post carrier ends so that they are in line. This part depends on the length of the string, but undo between 10 and 15 of the twists. Place it on, and adjust the string jig so that there is no sag on the string. Do not have the string too tight as this will have an effect on the string length that is being made.

If you do not have a string that is the correct length:

Set the string jig to a length that is 3½ inches (9 cm) shorter than the length of the bow. This measurement depends on the make and

model of the bow but it will bring you close to the required length for subsequent string making.

Take the old string off the jig. Turn the jig ends so they are square to the line of the jig. Loosely tie one end of the string material to a string post about 2 centimetres below the groove on the post which takes the string material. Then wind the string material round the posts (keeping to the groove at the top of each post) making sure the rotation starts by going round the post that is the nearest to the post the string material is tied to, see illustration 3.2. The secret to a good, reliable string lies in the equal tension of each strand. If the tension is not equal between all strands, the string breaks because the pressure was held only by a few strands. As the pressure of beginner bows is always less than 25 lbs, it is recommended making strings using Dacron with eight strands. If you are making an 8 strand string go round the jig 4 times, if you are making a 10 strand string then the need will be to go round the jig 5 times. Always make sure the finishing end is tied lightly to the post that is past the post to which the start of the string material was tied. This allows an overlap of the string material that is secured under the loop serving.

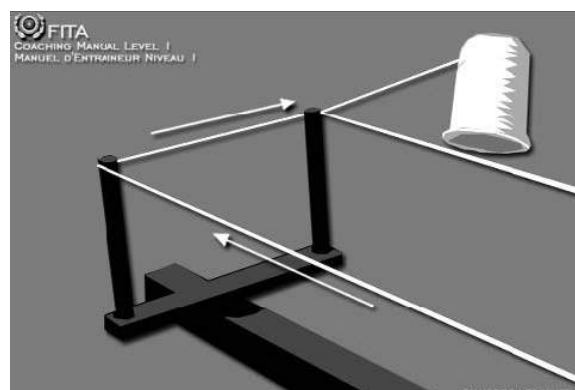

Illustration 3.2

Serving the loop:

Make the first loop to be served the end of the jig that has the string material overlap, this will be beneficial and stop those ends coming loose as the string manufacture continues. Untie the starting end that was tied 2 centimetres down the first post and loop it round the post groove under the windings, see illustration 3.3. All servings

must be wound on the string in the same direction; this will ensure that they will not come loose when twists are added to the string for active use. I prefer to serve from right to left having the serving spool coming toward me from under the string. If all servings are completed this way they will all be in the same direction.

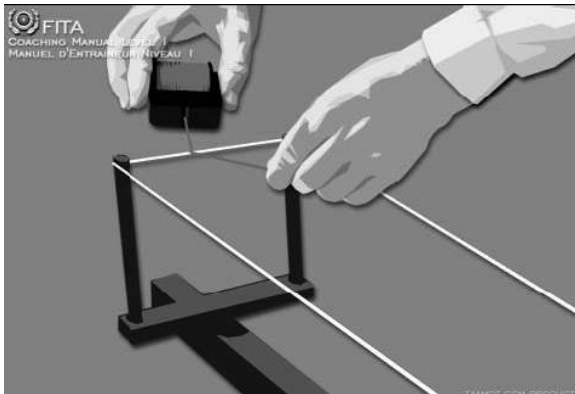

Illustration 3.3

Making the loop:

When the correct length of serving has been reached, see illustration 3.4, turn the jig swivelling end 90 degrees and slide the string round the jig so that the served section is now round the outside post.

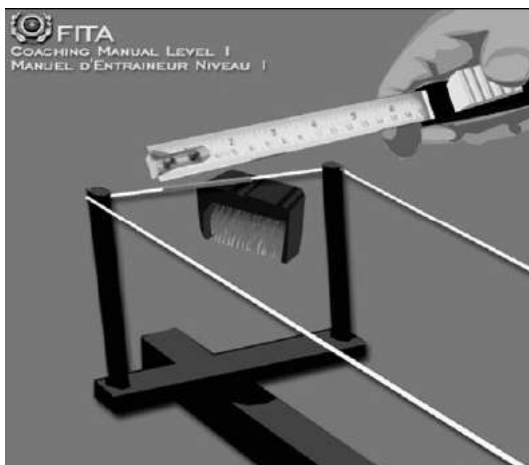

Illustration 3.4

The end still attached to the serving tool should be about 4 millimetres shorter than the end where the serving had been started; this will allow 4 millimetres of serving overlap giving a neat join to the loop, see illustration 3.5.



Illustration 3.5

Continue serving the now joined loop in the same direction as before. Make sure the two loose ends of the string material are held along this section and served over. After about 6 centimetres they should be cut off, make sure that there are at least 4 winds of serving between cutting off the first loose end and cutting off the second loose end. This will stop having a small step along the serving, which may possibly wear and cause the serving to break during use.

Serving to the correct length:

Wind the serving on to within 1 centimetre of the desired length i.e. about 10 or 12 centimetres, see illustration 3.6 (this measurement depends on the limb Recurve curvature). Keeping the tension on the serving, pull the serving tool away from the string and cut the serving thread leaving about a 45-centimetre length for finishing off the serving.

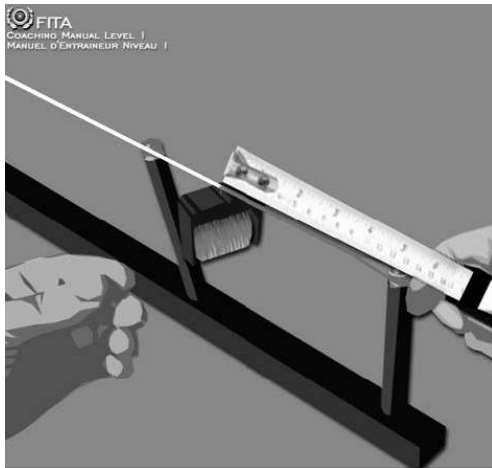

Illustration 3.6

Making a neat end to the serving:

Pass the tail end of the serving over the string with the left hand about 3 centimetres from the end of the serving; make a loop holding this with the fingers of the right hand. Using the left hand pass the tail end to the thumb and forefinger of the right hand. Then keeping the loop tight, bring the tail end through the loop under the string and pass it on to the left hand see illustration 3.7.

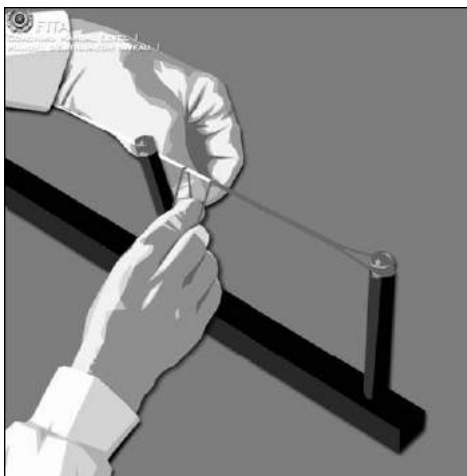

Illustration 3.7

Serving back through the loop:

Continue passing the tail end of the serving over the top of the string with the left hand to the thumb and forefinger of the right hand, bringing it through the loop and passing it back to the left hand. This part of serving will be running through the loop and toward the serving already done with the serving tool, see illustrations 3.8 & 3.9.

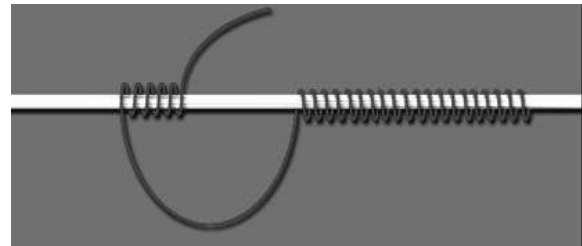

Illustration 3.8



Illustration 3.9

Locking off the tail end:

Make this part of serving for about twelve turns or until about 1 centimetre long. Place the tail end under the loop of serving thread just as it comes off the end of the serving already completed with the serving tool, and lock it there by keeping pressure on the loop, see illustrations 3.10 & 3.11.

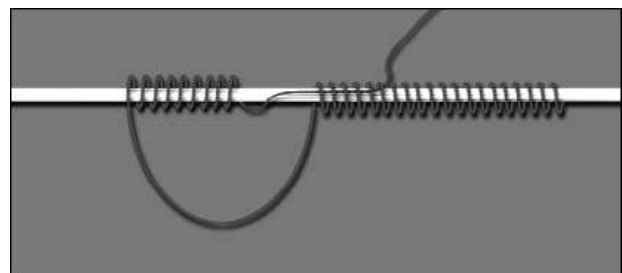

Illustration 3.10



Illustration 3.11

Finishing off the serving:

Once the tail end has been secured, and keeping the loop tight, wind it round the string, continuing on from the serving already done with the serving tool. In doing this the serving will get longer and the part that was wound through the loop will get shorter. By serving manually the right part over the tail end, you un-serve the left end, see illustration 3.12.



Illustration 3.12

Pulling the end through:

When all of the winds on the loop end have been wound off, still keeping the loop tight, pull the tail end until the loop has completely gone. The thumb of the left hand can be used or even a pencil can be placed under the loop to maintain the tension whilst the tail end is

being pulled through. By pulling, the end strand can twist on itself and "refuse" to pass under the server. Use a pencil, or similar, to help guide it through, see illustrations 3.13, 3.14 & 3.15.

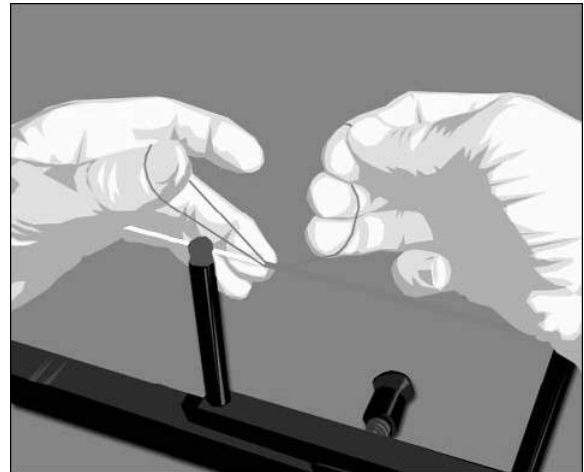
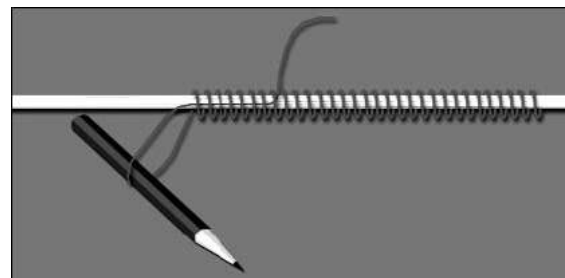

Illustration 3.13



Illustrations 3.14

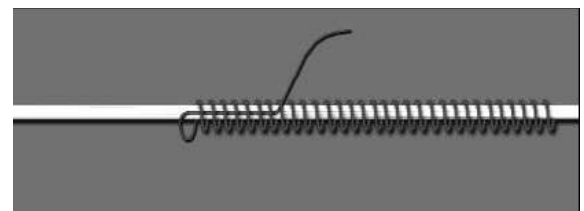

Illustration 3.15

Cutting off the tail end:

When the tail end has been pulled through and the serving is nice and tight the tail end can be cut off. To do this place a knife flat on the serving section that has just been wound back to meet the serving that was done with the serving tool, then gently cut off the tail end. If the knife is placed on the serving which was done using the serving tool the serving where the tail end comes out may inadvertently be cut, as this will be a little proud of the main serving due to the tail end being underneath it, see illustration 3.16.

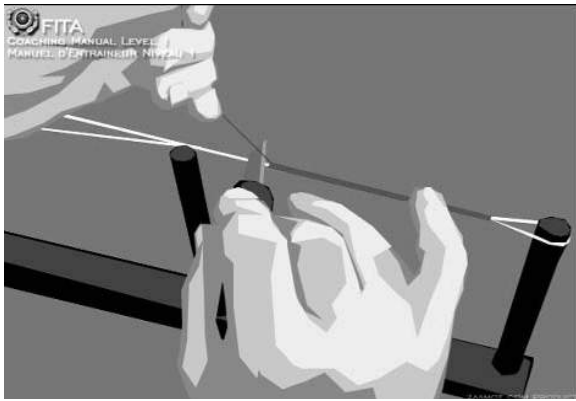

Illustration 3.16

Completing the other end of the string:

When the first end of the string is complete turn the string jig round and do exactly the same the other end. Bear in mind that the top loop of the string must be large enough to slip over the top limb when stringing the bow. By serving both ends in the same way the servings will be correct when the string is twisted for fitting to the bow.

Twisting the string in the correct direction:

When both end loops of the string are completed the string should be fitted to the bow so that the centre serving can be added. To do this fit the top loop over the top limb and slide it down about 10 centimetres. Take hold of the loop for the lower limb and twist it for 10 to 20 turns, see illustration 3.17 (make sure that the turns are in the correct direction otherwise the end servings may come loose).



Illustration 3.17

The direction of twist shown is the correct direction for the direction of serving shown in this document. If the string is twisted in the opposite direction to the serving, the serving will possibly come loose and may move during use. All three servings must be wound

on the string in the same direction, see illustration 3.18.

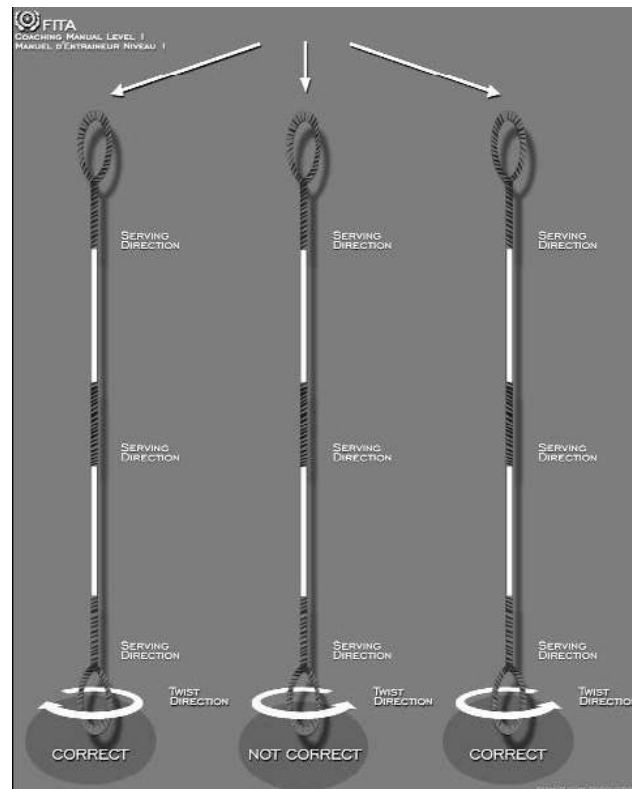

Illustration 3.18

Some people serve their strings in a different direction, or way, than shown in this leaflet. These three diagrams may help in determining the direction the string should be twisted to stop any of the servings coming loose during use.

Getting the correct bracing height:

If the new string is not to the correct length for a given bracing height then the length may be adjusted by adding or reducing the number of twists in the string. The minimum recommended is approximately 1 full turn every 7.5 centimetres, there is no maximum but remember the more twists in the string it will take longer to settle to its working length. It will also be fatter which may give a reduced performance. The bracing height may be measured from the throat of the bow grip to the string, as shown in illustration 3.19, or from the string to the centre of the pressure button plunger.

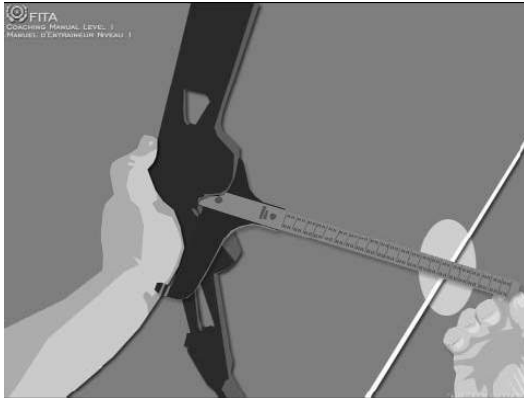

Illustration 3.19

Before bedding in the wax have the brace height 3 millimetres higher than the required final height as bedding in the wax will increase the string length thus lowering the brace height. Take a piece of leather; fold it round the string and rub up and down the full length of the string, see illustration 3.20. Most string materials do not need extra wax applied to the string before undertaking this task, but if the string material is un-waxed then a few rubs of a Bees wax block on the string will be necessary before the string is rubbed with the piece of leather.

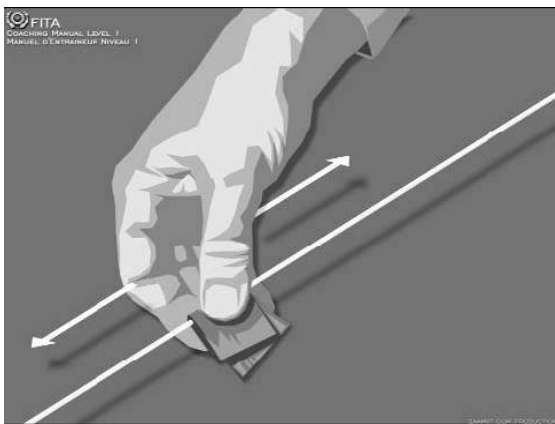

Illustration 3.20

The centre serving.

With the bracing height set to the desired height the centre serving can be applied. Choose a serving material with a diameter to give the correct fit for the size of nocks to be used. This will save having to build up the nocking area to get a good fitting nock, or vice versa, having to replace the serving because the nock is too tight. Start the serving at a height above the desired nocking point position to give adequate string and finger protection, a suggested height of approximately 6.5 centimetres would be sufficient, see illustration 3.21. The serving

should be served in the same direction that the end loops were served i.e. from right to left taking the serving spool over the top of the string and away from you.

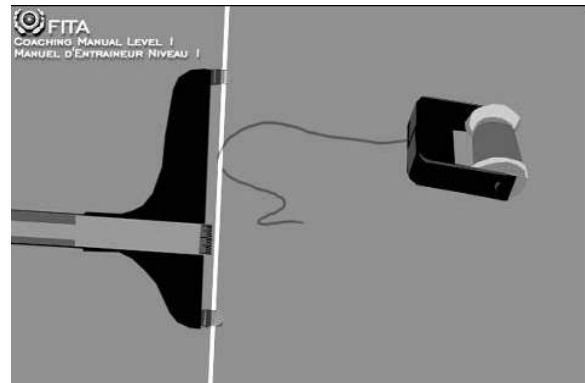

Illustration 3.21

Serving the required length:

When the serving is 1 centimetre shorter than the required length, i.e. about 16 centimetres, see illustration 3.22, (this length depends on the individuals preference) continue to finish off the serving exactly the same as the top and bottom servings were finished. Remember the serving gives protection to the string should it contact the armguard during the completion of the shot. It also has a bearing on the tuning of the bow, the lighter the serving the faster the string will travel and heavier the serving the slower the string will travel. Different lengths and weight of the centre serving can be used for fine tuning the bow.

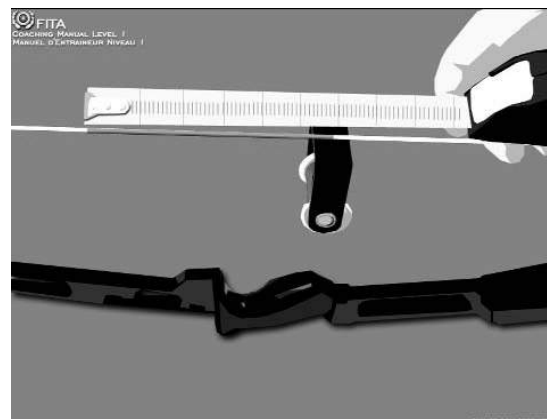

Illustration 3.22

It is usually easier to start the serving on the right and to work toward the left, with the serving spool coming toward you from underneath the string. If you serve this way, which is the way the end servings were done,

all three servings (the end loops and centre serving) will be all the same way.

When the serving is 8 to 10 millimetres short of the required length, pull about 30 centimetres of serving off the spool - make a loop and serve back toward the serving through the loop just made. This serving does not need to be tight but the spool must be turned around the string in the same direction as the serving was applied. Make sure that the loop is always kept tight otherwise the serving on the right of the loop will come loose, which will cause a problem when the string is in use.

When this reverse serving is about 8 to 10 millimetres long bring the serving on the serving spool out and trap it under the right hand side of the loop. Continue the serving by turning the right side of the loop toward you from underneath the string, (the same direction as the spool was used earlier) see illustrations 3.23 & 3.24. As this is done the serving on the left-hand side of the loop will get shorter. Reduce the tension of the server before unrolling the end strand. This allows it to detach easily.

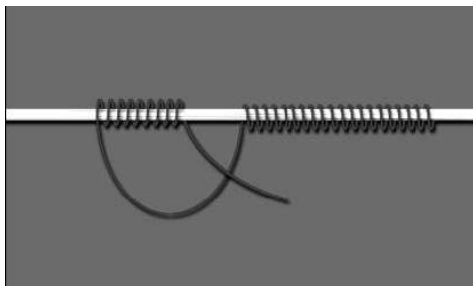

Illustration 3.23

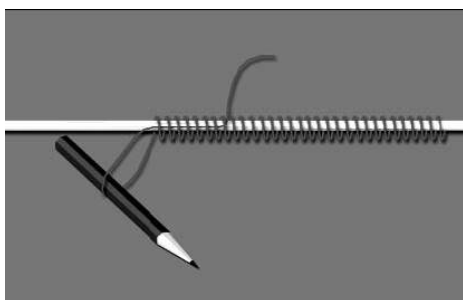

Illustration 3.24

After the centre serving is complete hold the bow horizontally and place the arrow on the string so that it is hanging straight down. If the centre serving is a good fit the arrow should hold onto the string and only fall off when the string is give a light tap with a

finger, see illustration 3.25. This can also be done when just a few centimetres have been served, if the arrow nock is too tight and a thinner material is needed it will save undoing the whole centre serving. When the centre serving is confirmed as a good fit it should be finished off the same way the end serving were finished.

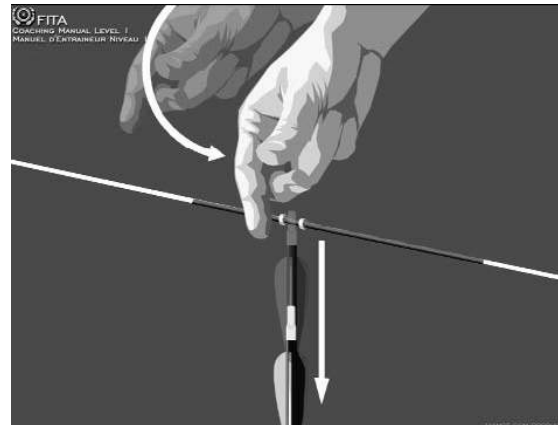

Illustration 3.25

It is very important to have a good fit between the arrow nock and the centre serving. Sometimes nocking point enlargement is necessary to ensure a proper nock fit when small strings are used on light weight bows. This may be achieved by adding a second layer of very thin serving, or dental floss, over the area of the nocking point, approximately 2 cm long. A little fletching glue can be wiped over this area as the serving progresses, but take care not to use too much as it makes the string stiff at that point. The best way is to add some strands of Dacron under the serving when making the string. These additional strands must be kept stretched as you serve around them, see illustrations 3.26 & 3.27.

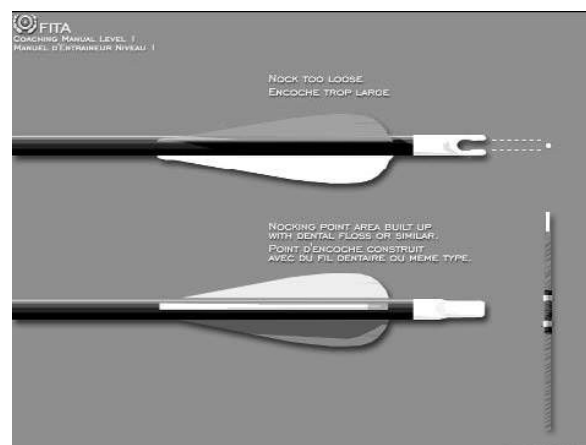

Illustration 3.26

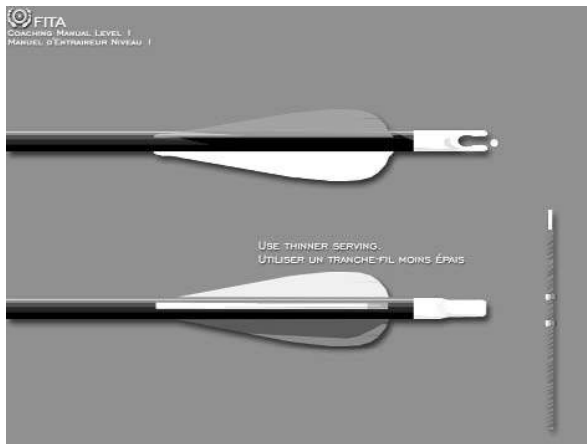

Illustration 3.27

The nocking point:

The correct height of the nocking point depends on many things. A suggested starting point is to have the top of the bottom nocking point about 5 mm higher than where the bottom of the shaft makes a 90 degree angle with the string, see illustration 3.28.

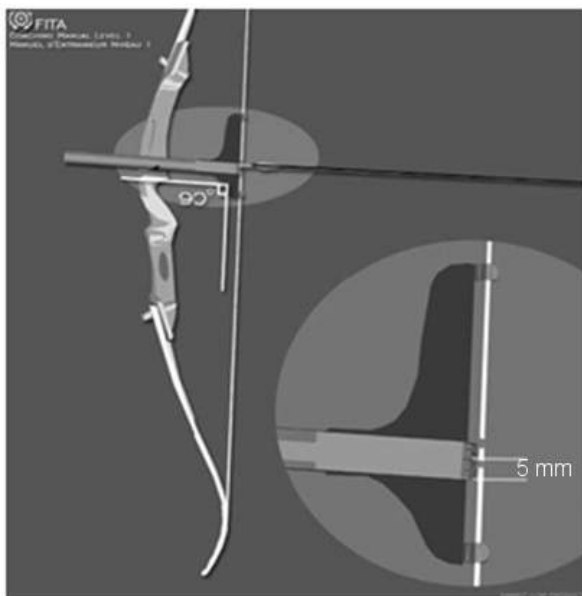

Illustration 3.28

Nock locators may be added in two ways. A manufactured nock-set is available that is clamped on the string with special pliers. Another method is to use a standard heavy thread, see illustration 3.29, then fixing this with fletching cement to form a small neat ring around the serving. This knot must be firm and uniform. Apply another thin coat of glue over the entire nock locator, and then leave it to dry. The nock locators may be above and below the nock.

After shooting about 30 arrows, re-measure the brace height. It has most likely decreased and will need resetting. If this is the case check the nocking point and adjust if necessary.

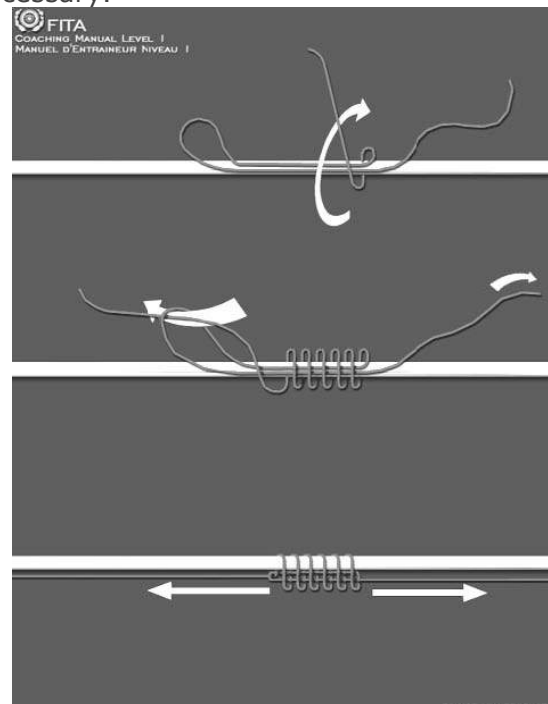

Illustration 3.29



4. How to make your own bow stringer:

Materials needed:

- 2 meters of rope,
- small piece of rubber or matting,

Use a solid 2 meters long rope and make it into a loop. Put the bottom limb on some sort of cushion, small rubber mat, or a piece of carpet...anything to avoid scrapping the bottom limb tip on a rough floor.

Fold the rope in two equal parts and put it astride on the bow grip. Place your feet in the loops as shown in illustrations 4.1 & 4.2.

Pull on the top limb towards you and place the top string loop on the top bow tip. Beware not to pull the limb directly toward your face, if the lower limb or rope slipped an injury may occur as a result.



Illustration 4.2

Always check the good positioning of the string, particularly on the bottom limb tip, before releasing your pull effort,.

There is more information available in the FITA Coaching Manual Level 1.

~~~~~ 0 0 0 ~~~~~



Illustration 4.1

## 5. How to make your own sight:

### Materials needed:

- stick of bamboo or wood similar to the characteristics of bamboo,
- screw of 3.5 cm in length,
- adhesive tape,
- a piece of hard rubber foam,
- tack of 2 cm in length,
- screw driver,
- hammer,
- knife,
- saw blade,
- boring bit (3),
- a plastic tube with an inner diameter of 4.5 mm,

Take the stick of bamboo or wood with similar characteristics and cut out a blade with a length of 18 cm, a width of 1 cm and a thickness of 2 mm. This bamboo stick serves as scale bar of the sight, see illustration 5.1

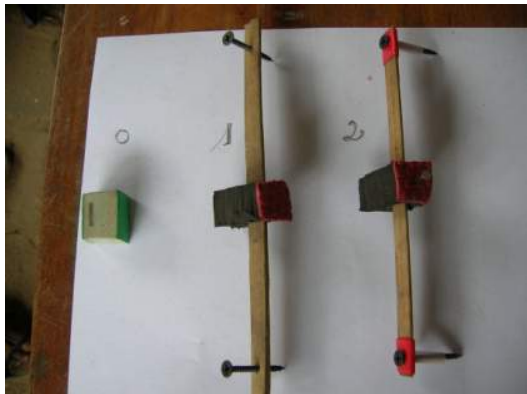

Illustration 5.1

Take the block of hard rubber foam with a length of 3 cm and a width of 2 cm to serve as slider. Cut a hole for the blade of bamboo in such a manner that you have 1/3 of space between the riser and the scale bar and 2/3 of space on the other side of the scale bar. This makes it easy for the rubber foam to slide along the wood without fouling the riser, see illustration 5.2.



Illustration 5.2

Drill a hole 7.5 mm from each end of the scale bar and then put adhesive tape around the bamboo blade where you have drilled the two holes. Put the screws through the adhesive tape and into the holes, see illustration 5.3.



Illustration 5.3

Put a piece of bamboo with an inner diameter of at least 4.5 mm and a length of 1 cm around each of the screws. Then fix the sight to the back of the riser, using the two screws, at the level of the sight window, see illustrations 5.4 and 5.5.



Illustration 5.4



Illustration 5.7

~~~~~ o o ~~~~~



Illustration 5.5

Insert a thin piece of bamboo through the foam slider on the sight track leaving approximately 2 cm from the inner side of the sight window. This visible end of the bamboo serves as your sight pin, see illustrations 5.6 and 5.7.



Illustration 5.6

6. How to make your own arrow rest

Method #1:

Materials needed:

- a paper clip,
 - double sided sticky tape,
 - adhesive tape,
 - a pair of pincers or pliers,
 - a pair of scissors,
 - a small felt pad,
- See illustration 6.1.1.



Illustration 6.1.1

Stick some double sided sticky tape to the riser where the arrow rest is to be fitted, see illustration 6.1.2.



Illustration 6.1.2

Open the paper clip so that it is at a 90 degree angle, see illustration 6.1.3.



Illustration 6.1.3

Cut the bottom (horizontal) part of the paper clip, see illustration 6.1.4.



Illustration 6.1.4

Cut paper clip, see illustration 6.1.5.



Illustration 6.1.5

Bend the cut arm forward to approximately 45 °, see illustration 6.1.6.



Illustration 6.1.6

Put the cut paper clip on the double sided sticky tape, see illustration 6.1.7.



Illustration 6.1.7

Bind some adhesive tape over the paper clip, see illustration 6.1.8.



Illustration 6.1.8

If needed a lightweight felt spacer pad can be fitted to get the arrow aligned using the centerline of the bow, see illustration 6.1.9.



Illustration 6.1.9

~~~~~ o o o ~~~~~

**6. How to make your own arrow rest**  
**Method #2:**

**Materials needed:**

- a piece of stiff wire 7.5 cm long,
- a piece of thin tin/aluminium 3 cm long 1 cm wide,
- a pair of pincers or pliers,
- three small tacks 1cm long,
- a small rubber band,

Bend the piece of wire, in the middle, making a 90 degree angle. Bend one end into a loop as shown in illustration 6.2.1.



Illustration 6.2.1

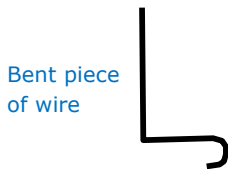

Shape the piece of tin/aluminium so that there is a small tunnel just big enough to take the size of the wire, also make two holes for the tacks to go through which will fix the arrow rest to the bow, see illustration 6.2.2.



Illustration 6.2.2

Bent piece of tin/aluminium

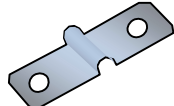

Using the two tacks fit the bent piece of tin/aluminium to the riser along with the bent piece of wire. It should be fitted in the sight window just above the shelf. The bent piece of wire should be placed as shown in illustration 6.2.3.



Illustration 6.2.3

Bend the piece of wire sticking out of the top of the fixing plate so that it is parallel to the sight window shelf, as shown in illustration 6.2.4.



Illustration 6.2.4

Fit the third tack to the outside of the riser at the same level of the arrow rest. One loop of the rubber band can then be fitted to this tack, and the end of the band can be fitted to the loop on the back of the bent piece of wire, see illustration 6.2.5.



Illustration 6.2.5

The arrow rest is now fitted and ready for use, see illustration 6.2.6. If needed a lightweight felt spacer pad can be fitted to get the arrow aligned using the centerline of the bow.



Illustration 6.2.6

~~~~~ o o ~~~~~

6. How to make your own arrow rest Method #3:

Materials needed:

- a knife,
- a piece of thick leather,
- a plastic carton,
- double side sticky tape,
- glue (fletching type),

Take the piece of leather and cut out a piece 3cm long by 2cm wide. Cut a slit in it 1cm long and 1cm in from one end. Cut a piece of plastic to the shape similar to that shown in illustration 6.3.1.

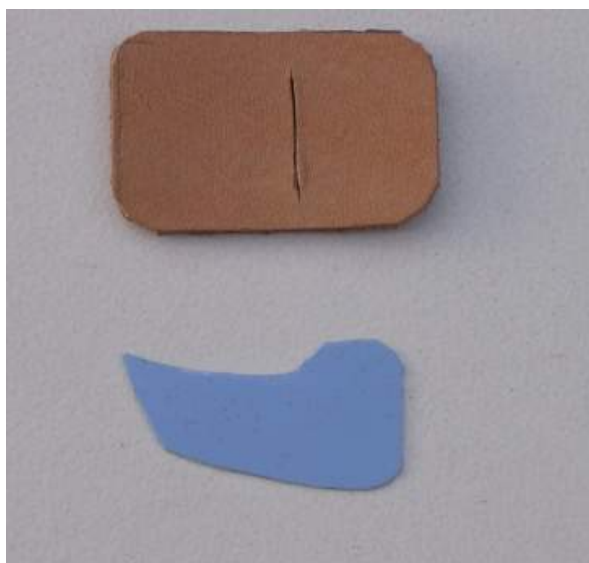

Illustration 6.3.1

Bend the piece of plastic as shown in illustration 6.3.2



Illustration 6.3.2

Pass the piece of plastic through the slit as shown in illustration 6.3.3.

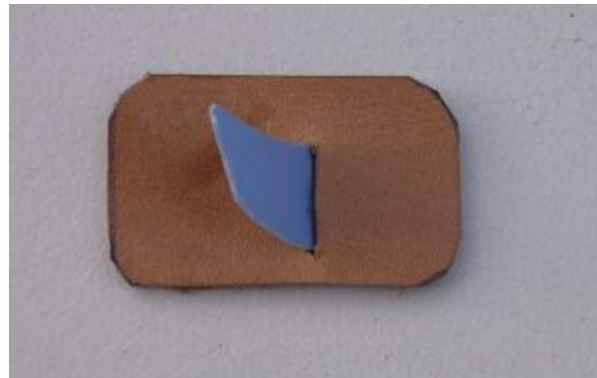

Illustration 6.3.3

Cut a small piece of double sided sticky tape and stick the back of the plastic arrow rest to the back of the piece of leather, as shown in illustration 6.3.4.

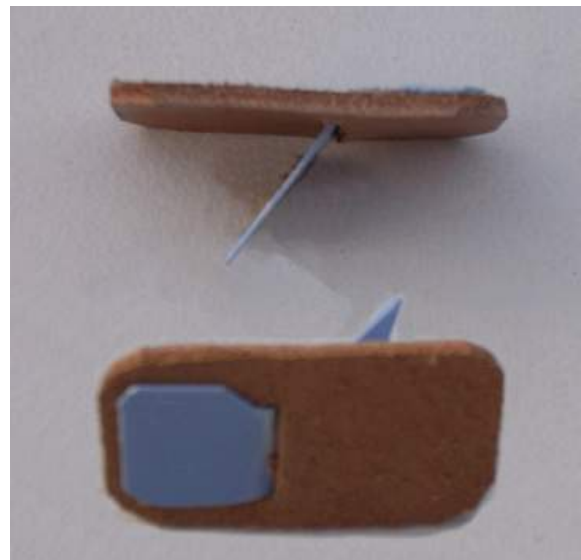

Illustration 6.3.4

Put a piece of sticky tape on the back of the now finished arrow rest and fix it to the bow just above the arrow shelf as shown in illustration 6.3.5. If a pressure button is being used a hole of the appropriate size can be cut in the arrow rest for the pressure button tip to pass through. If a pressure button is not being used a small piece of leather can be fixed in the appropriate place on the arrow rest so that the static arrow line-up can be achieved, see illustration 6.3.6.



Illustration 6.3.5



Illustration 6.3.6

~~~~~ 0 0 ~~~~~

## 7. How to make your own pressure button:

### Materials needed:

- a thin blade of bamboo 20 cm long, 1 cm wide and 2 mm thick,
- three small screws 2 cm long,
- three pieces of hard rubber foam,
- adhesive tape,
- an 8 mm boring bit,
- a 3 mm boring bit,
- a hammer,
- a screw driver,
- a knife,
- a small piece of an arrow shaft,

Drill a hole in the riser just above the arrow rest using the 8 mm boring bit, as shown in illustration 7.1.



Illustration 7.1

Cut off a piece of the arrow shaft with a length of 4 cm and see if it fits into the hole.

Take the bamboo blade and drill three holes with the 3 mm boring bit. There should be one hole in the centre of the blade and one 7.5 mm in from each end of the blade.

Cover the holes with the adhesive tape and put the two screws through the tape and into the holes.

Cut three pieces of hard rubber foam with a length of 2 cm, a width of 1 cm and a height of 7.5 mm each. Put a piece of this foam onto each of the screws fitted through the bamboo blade. Drill a hole into the third piece of hard rubber foam at one end of the bamboo blade

and put the 4 cm shaft into it, which is then fixed by the third screw, see illustration 7.2.



Illustration 7.2

Fix this construction to the exterior of the riser by inserting the 4 cm wooden shaft through the hole, see illustration 7.3.



Illustration 7.3

~~~~~ 0 0 0 ~~~~~

8. How to make your own draw length indicator (clicker):

Materials needed:

- a thin blade of bamboo 20 cm long, 1 cm wide and 2 mm thick,
- a small screw 1 cm long,

Take the small strip of bamboo, same kind as for the plunger and cut it really thin, see illustration 8.1.



Illustration 8.1

Roll some adhesive tape around the bamboo strip at one end and drill a small hole 15mm from the end of the bamboo suitable to take the size of screw being used, see illustration 8.2.



Illustration 8.2

Then fix it in the bow window with the small screw at a height where the lower part of the blade will be on the arrow when the arrow is paced on the arrow rest. Then adjust at will to suit the archers draw length, see illustration 8.3.



Illustration 8.3

~~~~~ 0 0 ~~~~~

## 9. How to make your own arrow shafts:

### Materials needed:

- bamboo sticks,
- candle,
- rasp or file,
- knife,
- saw,
- blade,
- matchbox,
- sandpaper.



Illustration 9.2

### Determine the length of shaft required:

The length is the distance between the corner of the mouth and the space between the thumb and the index finger of the outstretched bow arm with the bow hand pressed to a wall and turning the head to the hand on the wall, see illustration 9.1. Always add 10 cm for beginners.



Illustration 9.1

Firstly you need to select bamboo sticks to suit the bow weight and the archer's draw length. The shafts selected would nominally be between from 4 to 8 mm in diameter. In general, they have a length of 1.5 m to 2 m and after straightening it may be possible to make 2 to 3 shafts from one stick. It is best to dry them for 45 days before using them. Straightening the shafts can be achieved by using the heat of a candle then straighten them out by putting some pressure in the direction needed to get them straight, see illustration 9.2.

When these bamboo sticks are being straightened, it is best to use a concentrated flame like that of a candle or a similar "heat". You must heat up the knots of the bamboo and then you can straighten the stick. Do not try to straighten or bend the part between two knots, you could break the stick, see illustration 9.3.



Illustration 9.3

When they are straight the knots can be smoothed out using the rasp or file. Then cut one end of the future arrow 2 cm after a knot, see illustration 9.4.

**NB:** Now we will affix the nock or make a slit instead of the nock.

Advantages: A knot near the nock prevents the splitting or fragmentation of the shaft at the slit.





Illustration 9.4

If you want to use a commercially available nock, decide which nocks you will be using "insert nocks" or "cone fitting nocks" then you should start making the end of the shaft to suit that particular fitting, see illustration 9.5.



Illustration 9.6

If you do not have commercial nocks at hand just slit the wood and either put some tape around the end of your arrow, or bind with some serving or string material, so the split doesn't get bigger, see illustration 9.7.



Illustration 9.5

When the end of the arrow has been shaped to accept the selected nock you can fit the nock onto your arrow, see illustration 9.6.



Illustration 9.7



**An alternative method of making a nock for an arrow.**

If smaller diameter shafts are available, such as old arrows or carbon shafts etcetera then another method of making nocks may be sought, such as:

You need an old ball point type pen, cut off the end so as to get a tube, see illustration 9.8.

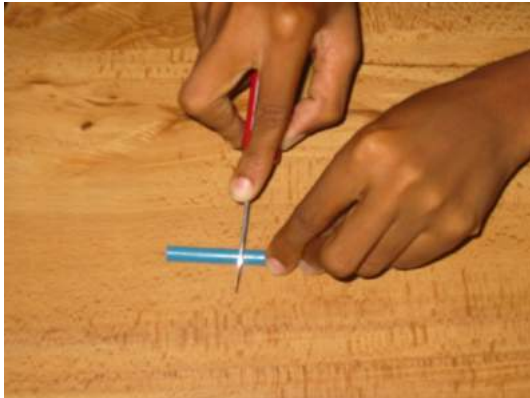

Illustration 9.8

Here we managed to get 3 tubes out of one pen.



Illustration 9.9

Drill the inside to get the right size hole to fit over the end of the arrow.



Illustration 9.10

Use glue to stick it onto the back end of the arrow.



Illustration 9.11

Fit the plastic tube to the shaft ensuring that it lined up with the shaft and runs true when the shaft is spun.



Illustration 9.12

Finally use a small round file or something similar to cut out the slot for the bowstring.



Illustration 9.13

**Making and fitting the point.**

You have two choices, build your own point or just insert a point that is commercially available, see illustration 9.14.



Illustration 9.14

To build your own point you need a nail. Cut the end of the shaft so that it is point shaped, this could be done using a pencil sharpener, see illustration 9.15.



Illustration 9.15

Take a 3" (7.5 cm) nail and cup off the flat head, see illustration 9.16.



Illustration 9.16

Using a suitable glue insert the blunt end of the nail 2½ inches (6 cm) into the shaft, see illustration 9.17.



Illustration 9.17

If the hole of the shaft is too small use a drill bit to enlarge it to suit the nail. If the hole in the end of the bamboo shaft is too big, roll some fine thread over nail, and use a suitable glue to hold the nail in the end of the shaft. Or, sawdust mixed with glue can be pushed into the end of the shaft and the nail inserted using a little extra glue. See illustration 9.18, the finished item.



Illustration 9.18

~~~~~ 0 0 0 ~~~~~

10. How to make your own fletchings:

Materials needed:

- 2 rulers or similar,
- scissors,
- electrical insulating tape or similar,
- a ball point pen,
- a vane template of card, or an old vane.

Mark the length for the foot of each half vane on 2 plastic or metal rulers (or similar device).

Here we are making vanes of 6 cm long. The foot of each half vane is 2mm wide.

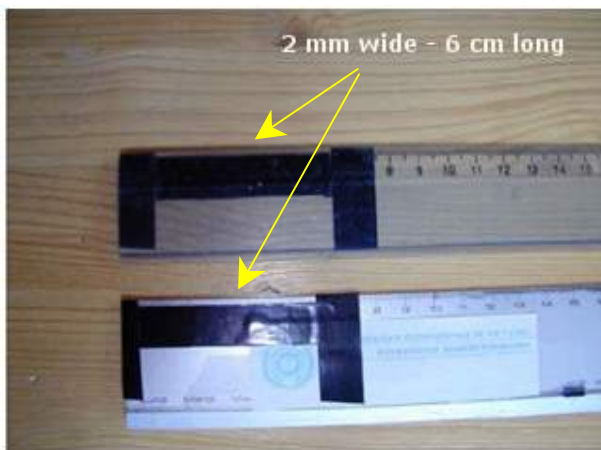

Illustration 10.1

Fix a piece of tape on each of these marks, illustration 10.2.

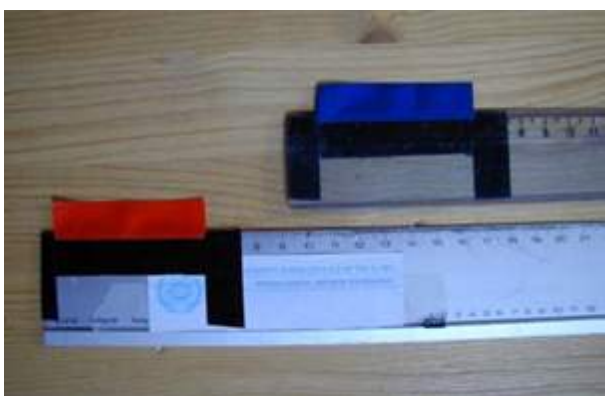

Illustration 10.2

Fold both half vanes and join them together, illustration 10.3.

If stiffer vanes are required a piece of thin plastic can be placed between the two halves of the vane.

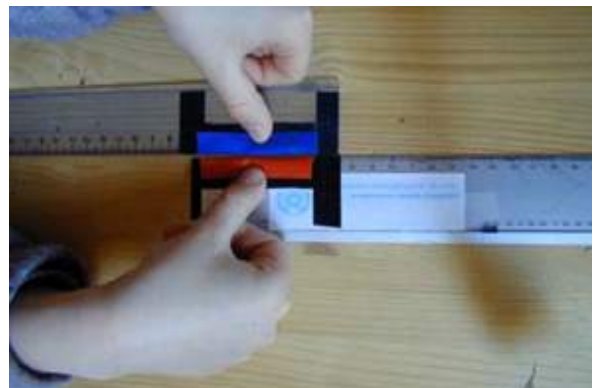

Illustration 10.3

The 2 unified pieces of plastic tape make the rough body of the vane.



Illustration 10.4

Fold the vane at the foot level on side A. This will act as the foot of the vane when completed, illustration 10.5.

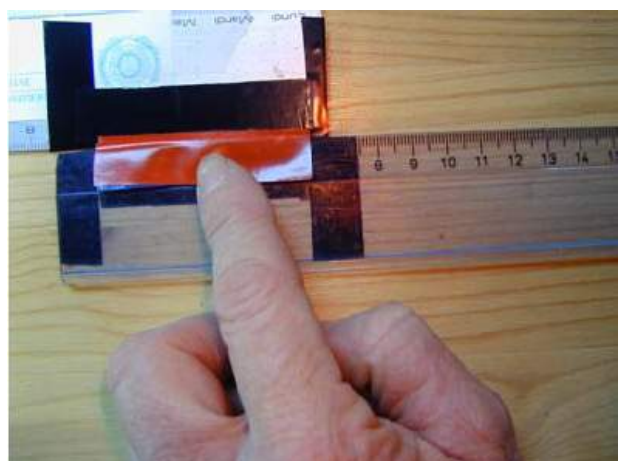

Illustration 10.5

Repeat the above for side B. This will act as the foot of the vane when completed, illustration 10.6.

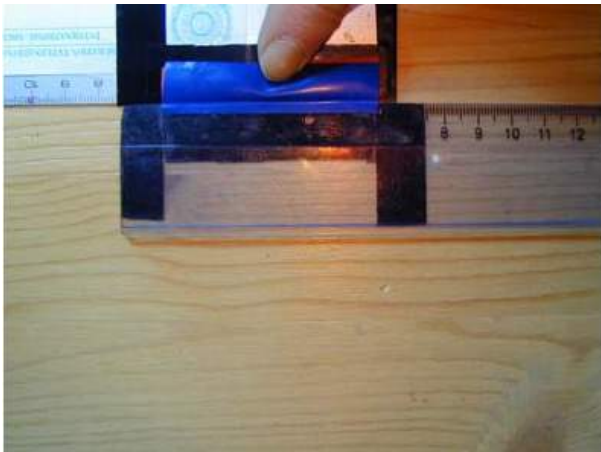

Illustration 10.6

Draw the shape of the vane that is required.

It would be easier if a template was used to draw round, as shown in illustration 10.7.

This can be done by making a template out of a piece of card or plastic. An old vane could also be used for this stage.

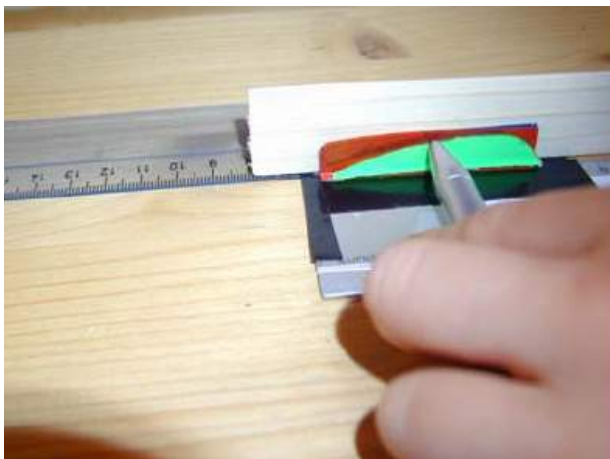

Illustration 10.7

Remove the vane from the rulers, illustration 10.8.



Illustration 10.8

Cut the vane round the line to shape the vane, illustration 10.9.



Illustration 10.9

Insert the cut vane in the fletching clamp, illustration 10.10.



Illustration 10.10

The vane is shown in the fletching clamp with both sides of the foot bent outwards, see illustration 10.11; this area will be stuck to the arrow shaft.



Illustration 10.11

Put the arrow into the fletching jig and slide the clamp into position, illustration 10.12.

Note: the fletching can be stuck to the arrow shaft by hand without using any jig, but this manual process requires a lot of care.



Illustration 10.12

Remove the clamp and press the foot edges down on the arrow shaft, illustration 1.13.

One vane fixed on the arrow shaft.

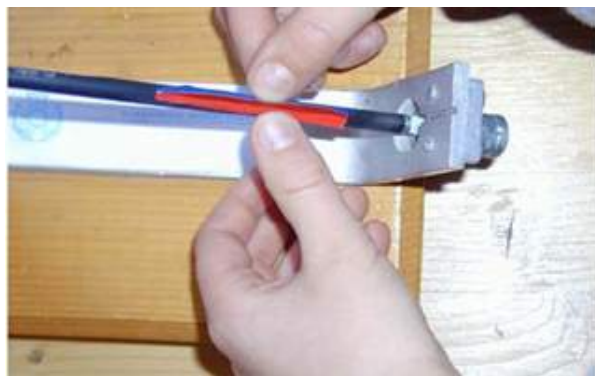

Illustration 10.13

Do this two more times to complete the fletching of the arrow.

Note: As the example shows in illustration 10.14 you can make vanes with 2 sides of different colours.

It is recommended to reinforce the nose and the tail of the fletching with a narrow strip of plastic tape.



Illustration 10.14

Special care

- * Choose quality tape

- * Fletched arrows to be stored properly, because the vanes could remain deformed.
- * Easily damaged when passing through the target mat.

Advantages:

- * Cheap
- * Many colours possible
- * Can shoot as soon as fletched
- * Light and thin material; hence make the arrow faster than rubber vanes.
- * Resistant to arrow friction on target.

~~~~~ o o ~~~~~



## 11. How to make your own finger protector (tab):

### Materials needed:

- a piece of thin pliable leather,
- scissors,
- a "tab" template for drawing round to get the right shape and size,
- pencil or ball point pen.

First you have to make one pattern per size required on paper or cupboard. If possible, use some commercially available tabs as a model, illustration 11.1.



Illustration 11.1

Put the pattern on the leather and draw round it making a line so that it can be seen and cut round, illustration 11.2.



Illustration 11.2

The leather is now ready to be cut out, illustration 11.3.



Illustration 11.3

Cut the leather according to your drawing, illustration 11.4.



Illustration 11.4

Also cut the hole according to the size of the middle finger, illustration 11.5.



Illustration 11.5

This is how it should look if you are shooting bare-bow I.e. three fingers under the arrow.



Illustration 11.6

Your tab is now ready for use; it fits on the hand as shown in illustration 11.7



Illustration 11.7

If you want to shoot with a sight and use a finger tab (Mediterranean string holding) you should make a cut 4 mm wide and 2 cm long between the index and middle fingers, as shown in illustration 11.8.



Illustration 11.8

~~~~~ o o ~~~~~

12. How to make your own arm guard (bracer):

Materials needed:

- a plastic bottle,
- scissors,
- elastic strip (2 pieces 30 cm long),
- a punch to make neat round holes.



Illustration 12.1

Cut a section of plastic from the bottle approximately 15 cm long and 7 cm wide. The measurement here is just a suggestion, the length, width and shape will depend on the size of arm it is to fit.

Punch two neat round holes in the front and two neat round holes at the back, as shown in illustration 12.2.



Illustration 12.2

The pieces of elastic are then threaded through the holes, as shown in illustration 12.3, and the ends can be looped together making like two large rubber bands. These loops should be large enough to fit the arm

but tight enough to stop the bracer from slipping down the arm.



Illustration 12.3

~~~~~ 0 0 ~~~~~



### 13. How to make your own finger sling Method #1:

#### Materials needed:

- a piece of polyester, or plastic rope 25 to 30 cm long and 2 to 4 mm thick,
- scissors or knife,
- a candle or cigarette lighter.

Put both ends of the rope between your fingers as shown in illustration 13.1.1 and burn rope ends.



Illustration 13.1.1

Put the two burnt ends together whilst they are hot and press so that the ends stick together, illustration 13.1.2.



Illustration 13.1.2

Wet your thumb and index finger so you don't burn yourself, and roll the joint to reduce the size of the melted material of the two ends, also so they stick very well together, illustration 13.1.3.



Illustration 13.1.3

You will now have a "big" loop of rope, illustration 13.1.4.



Illustration 13.1.4

Flatten the "big loop" keeping the joint in the middle away from the two ends of the loop; make a simple "small" loop as shown in illustration 13.1.5.



Illustration 13.1.5

And then tie the rest of the "big" loop of rope through the "small" loop, as shown illustration 13.1.6.



Illustration 13.1.6

The first loop is made; one finger (forefinger or middle finger) will pass through this loop. Have a test and make any adjustments that are necessary. Although either finger will pass through this loop, it is advisable to have the loops on the forefinger and thumb when shooting.



Illustration 13.1.7

Repeat the procedure on other end of sling making sure that the thumb can pass through this loop, make the required adjustment if necessary.



Illustration 13.1.8

Test the size of the finished "bow sling" making sure that there is enough room for the riser of the bow being used to fit in the hand with a little slack, as shown in illustration 13.1.9. If the bow sling is too tight the bow will not have sufficient freedom to react correctly when being shot. Make the required adjustment if necessary, if the bow sling is too short, start over again using a longer piece of "rope".



Illustration 13.1.9

~~~~~ o o ~~~~~

13. How to make your own finger sling Method #2:

Materials needed:

- If you are an adult with medium size hand and an industrial entry level bow, you need 50 cm of a flat tape.

The length of the tape may need to be modified as the length depends on the size of the hands and the size of the bow grip.



Illustration 13.2.1

Make a loop by tying the ends together by a knot or joint that will not slip when pulled with a reasonable force.



Illustration 13.2.2

Pass the loop over your thumb and forefinger, as shown in illustration 13.2.3 (see the demonstrator's right hand).

Suggestion: keep the knot at mid-distance of your two hands, as show in this illustration.

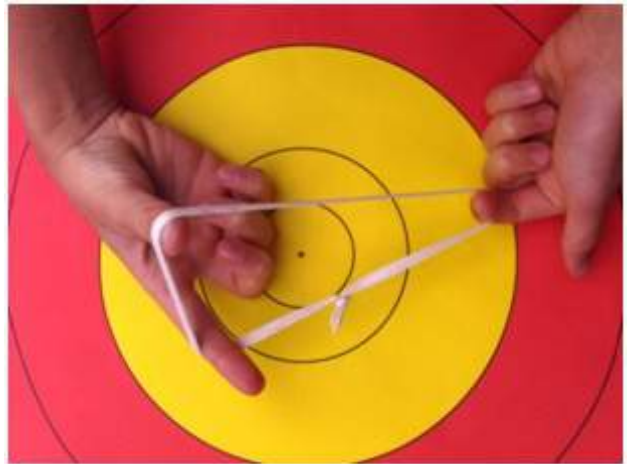

Illustration 13.2.3

Turn your hand upside down as shown in illustration 13.2.4 (see the demonstrator's right hand). One loop should be around your thumb, and one around your forefinger.



Illustration 13.2.4

Bring these two loops side by side and pass your forefinger into this "double loop", illustration 13.2.5.



Illustration 13.2.5

Make the same "double loop" for your thumb.

You have made a cheap and very efficient bow sling. Congratulations!



Illustration 13.2.6

~~~~~ 0 0 ~~~~~

### 13. How to make your own finger sling Method #3:

#### Materials needed:

- a measuring tape,
- a spool of sewing thread, needle and thimble,
- scissors
- A piece of flat leather, or a similar material 1 inch (2.5 cm) width.

Cut two parts from the leather strap as shown in illustration 13.3.1 and explained below.



Illustration 13.3.1

These two pieces are approximately 5 ½ inches (14 cm) of total length. The open slots are approximately 4 inches (10.5cm) from the square end. The left part of the strap is approximately ½ inch (12-13) mm of width, illustration 13.3.2.



Illustration 13.3.2

Overlap the two leather parts. See the suggested total length in illustration 13.3.3. The size depends on the size of the hand and the size of the riser grip, and adjustment may need to be made to suit this. You can temporarily sew the two parts together to confirm you have the correct length. You could also make the test with these two parts glued and tied together with a strong tape.



Illustration 13.3.3

Before the final stitching, pass the strap of each part in their respective groove as shown in illustration 13.3.4.

Do not worry if you have already stitched it together this can also be done with a sewed sling.



Illustration 13.3.4

~~~~~ 0 0 0 ~~~~~

14. How to make your own quiver:

Materials needed:

- a knife,
- two pieces of waste water pipe 50cm long (or longer to suit arrow length),
- two pieces of wood same diameter as inside of water pipe.
- sticky tape (electrical insulation tape),
- string or cord 1.2mtrs long.

The parts used to make this quiver can be seen in illustration 14.1.



Illustration 14.1

Slices of a branch from a tree can be used to block the ends of the pipe as shown in illustration 14.2.



Illustration 14.2

Tie one end of the rope round one end of a tube then tie the other end of the rope round the other end of the same tube. In the picture below the ends of the rope have been bound together using electrical insulation tape.

Bind both tubes together using the electrical insulation tape.

Take the rope loop and just off centre tie a looped knot as shown, illustration 14.3, this will allow the quiver to be at an angle when being used.



Illustration 14.3

The quiver is then ready to use, see following illustrations.



Illustration 14.4

If the arrow are too long for the tubes longer tubes should be used. A quick check to see if the arrows are too long for the tubes is to hold the quiver up by the belt loop and the quiver should stay at the correct angle without tipping forward, see illustrations 14.5 and 14.6.



Illustration 14.5

The angle of the quiver can be adjusted to suit each archer's requirement by adjusting the string loops round the belt.



Illustration 14.6

~~~~~ o o ~~~~~

**15. How to make your own ground quiver:**

**Material needed:**

- an old street cone,
- a drill,
- a large drill bit.

Just use an old street cone, and drill holes in it so as to fit in the arrows, see illustration 15.1.



Illustration 15.1

~~~~~ o o ~~~~~

16. How to make your own target:

Materials needed:

- 2 pieces wood 5cm x 10cm x 2.10m
- 2 pieces wood 5cm x 10cm x 1.25m
- 2 pieces wood 3cm x 40cm x 1.35m
- 1 piece wood 3cm x 10cm x 1.40m
- 2 pieces wood 3cm x 10cm x 1.60m
- 2 pieces wood 3cm x 10cm x 0.80.
- saw,
- plane,
- screw driver,
- variety of length screws,
- lots of cardboard.

The following guide will help you manufacture a target stand that will accommodate a 122cm face. Ideally the wood should be protected against humidity and moisture by painting or varnishing before assembling.

| Wood required for making a target stand | | | |
|--|------------|---------|-----|
| Description | Dimensions | | Qty |
| | Section | Length | |
| A - Front legs | 5cm x | 2.10 | 2 |
| B - Ties across legs | 10cm | mts | 2 |
| C - Base & top for cardboard slats | 5cm x | 1.25 | 2 |
| | 10cm | mts | 1 |
| D - Cross members | 3cm x | 1.35 | 2 |
| E - Rear legs | 40cm | mts | 2 |
| F - Brace between front and rear legs | 3cm x | 1.40 | 2 |
| | 10cm | mts | |
| G - Two wedge shape pieces of wood | 3cm x | 1.60 | |
| | 10cm | mts | |
| | 3cm x | 0.80 | |
| | 10cm | mts | |
| | -- X -- | -- X -- | |

Front view of the stand.

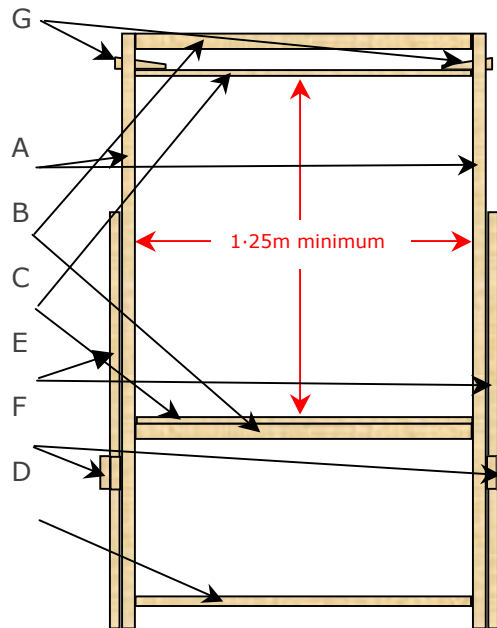

Many people have their own way of making and assembling things, so it will be left to the individual to assemble the stand in a way that suits them.

Side view of the stand.

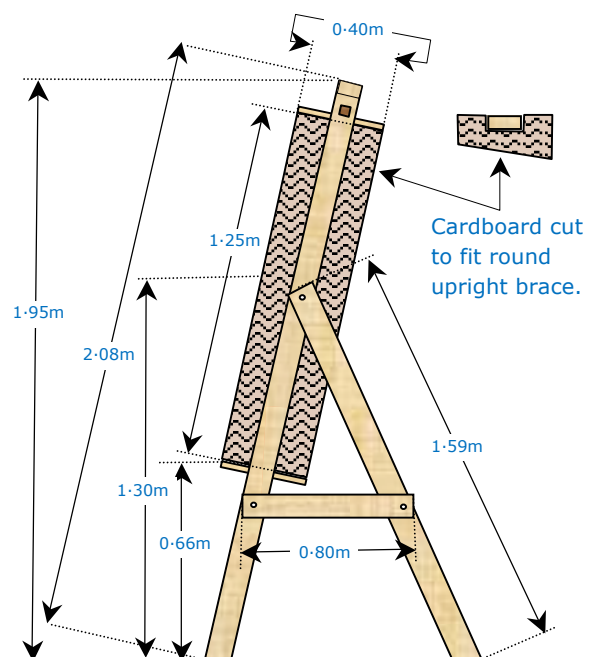

Here are some pictures of the stand when put together to help with visual knowledge.



Back view



Side view



Shelf which supports the cardboard

Now the stand can be filled with strips of cardboard, fibreboard or foam.

In order to get a flat surface of the filling material the ends of the material should be cut to fit round the upright brace, see illustration 16.1.



Illustration 16.1

This method will allow leaning the target without the filling material falling out.



The finished target

A rubber mat fixed to the top of the wood frame and hanging down behind the filling material will extend the life of the filling material. Do not stretch or nail the side of the

rubber mat as this action will reduce the effectiveness.

Subject to the filling material the complete target could be very heavy. A simple system to move such a heavy target is to put a groove in the bottom of the two front legs. A steel bar used as an axle with a wheel on each end can be placed in these two grooves which will allow the target to be moved like a wheel barrow, see illustration 16.2.

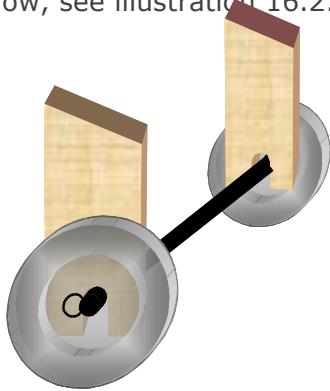

Illustration 16.2

~~~~~ 0 0 ~~~~~

## 17. How to make your own target stand:

### Materials needed:

The wood size should be approximately 10cm wide by 3cm thick.

- 3 pieces 2.05m long
- 2 pieces 0.30m long
- a saw,
- screws 5cm long,
- screw driver
- rope 4m long,
- wood plane,
- wood glue,
- an 8 or 10 mm bolt 15 cm long,
- washers and nut to fit the bolt.

This target stand is for accommodating a round Butt of 1.28cm in diameter.

The following guide will enable you to manufacture a target stand that will accommodate a 122cm face. Ideally the wood should be protected against humidity and moisture by painting or varnishing before assembling.

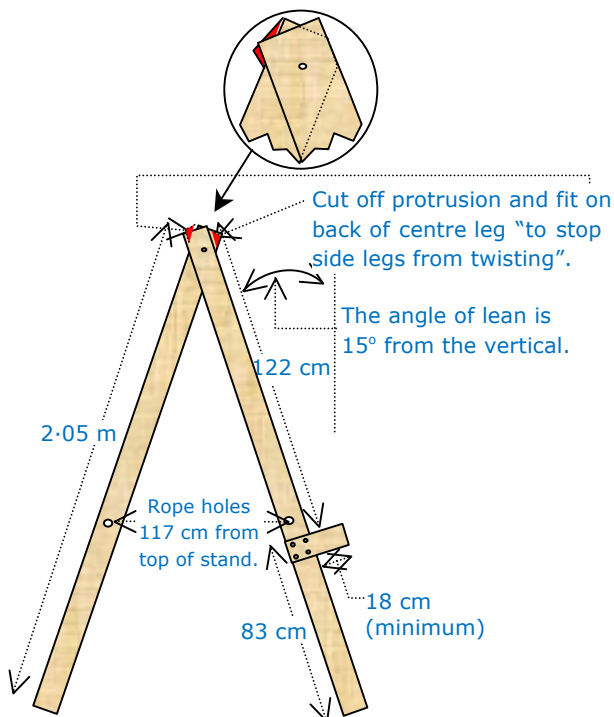

Illustration 17.1

Many people have their own way of making and assembling things, so it will be left to the individual to assemble the stand in a way that suits them.

The bolt creating the pivot point should be between 8 and 10 millimetres in diameter and 15 cm long with the excess length cut off to prevent arrows getting damaged should they penetrate the Butt and strike the bolt.

The legs should have a length of rope securing them to stop them moving or slipping during use.

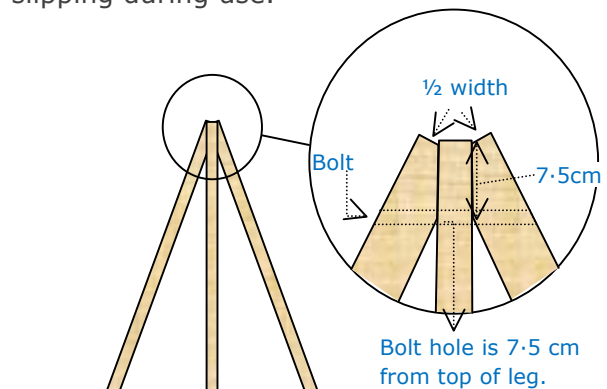

Illustration 17.2

When the Butt sits on the target stand the centre of the, pinned on, target face, should be 1.3 metres from the ground. There is a tolerance of  $\pm 5$  cm to allow for undulating ground, see illustration 17.3.

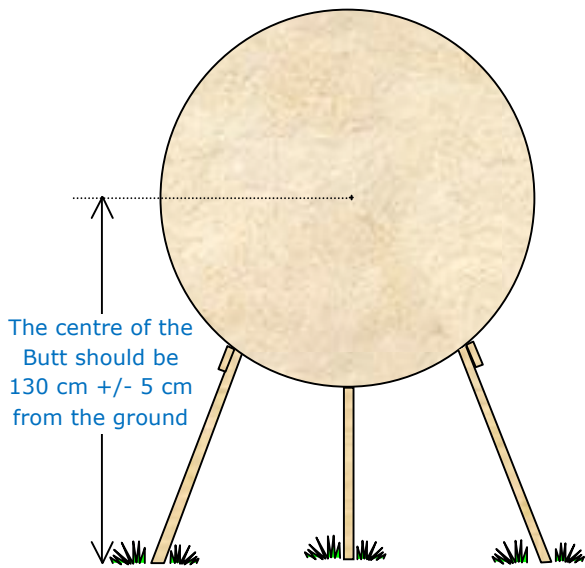

Illustration 17.3

The Butt should lean back at an angle of 15 degrees from the upright, and should be secured by guy ropes from the outside of the Butt to the ground behind the target. This is to avoid the wind blowing the target off the stand, which could cause damage to any arrows in the Butt at the time, see illustration 17.4.

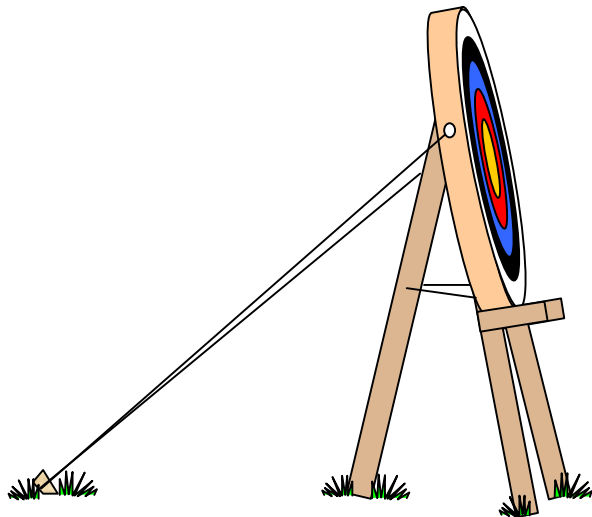

Illustration 17.4

~~~~~ 0 0 0 ~~~~~

18. How to make your own bow stand:

Materials needed:

- saw,
- drill,
- 6mm drill bit,
- 8mm drill bit,
- two 6mm bolts 5cm long, plus nuts and washers,
- two 6mm bolts 3cm long, plus wing nuts and washers,
- screws 2cm long,
- screw driver,
- a wood plane
- waterproof wood glue,
- dowelling 8mm diameter,
- two pieces of wood 2cm x 10cm x 60cm,
- one piece of wood 2cm x 10cm x 56cm,
- one piece of wood 2cm x 3cm x 60 cm,
- two pieces of wood 2cm x 3cm x 56cm,
- two pieces of wood 2cm x 3cm x 120cm,
- two pieces of wood 2cm x 3cm x 55cm.
- two pieces of aluminium (or similar) 12mm x 3mm x 62cm,
- t small piece of aluminium or tin 2.5cm x 5cm.

The following guide will enable you to manufacture a bow stand that will accommodate 10 bows. Ideally the wood should be protected against humidity and moisture by painting or varnishing before assembling.

Many people have their own way of making and assembling things, so it will be left to the individual to assemble the stand in a way that suits them.

Take the two pieces of wood 2cm x 3cm x 55cm and drill a 6 mm clearance hole in each piece 15mm in from one end. Also drill a 6 mm clearance hole in each piece 16 cm in from the other end, see illustration 18.1.

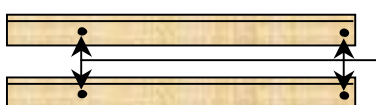

Illustration 18.1

Clearance holes to take the 6mm bolts.

Cut a slot 5cm long and 1cm deep in the piece of 2cm x 3cm x 56cm wood as shown in illustration 18.2

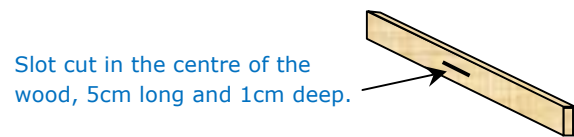

Illustration 18.2

Using the three aforementioned pieces of wood plus a piece 2cm X 10cm x 56cm and the piece 2cm x 3cm x 56cm assemble them as shown in illustration 18.3 using the waterproof wood glue plus the appropriate screws. The 2cm x 3cm x 56cm should be 15cm in from the end of the two side bars as shown.

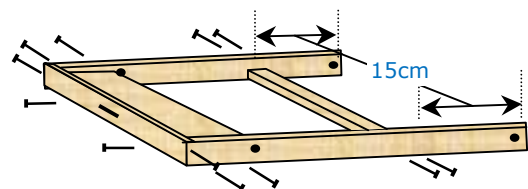

Illustration 18.3

Take the two pieces of wood 2cm x 3cm x 120cm and drill a 6 mm clearance hole in each piece 15mm in from one end, as shown in illustration 18.4.

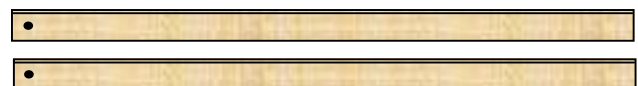

Illustration 18.4

Using the two aforementioned pieces of wood plus the two pieces of 2cm X 10cm x 60cm and the piece of 2cm x 3cm x 60cm assemble them as shown in illustration 18.5, using the waterproof wood glue plus the appropriate screws.

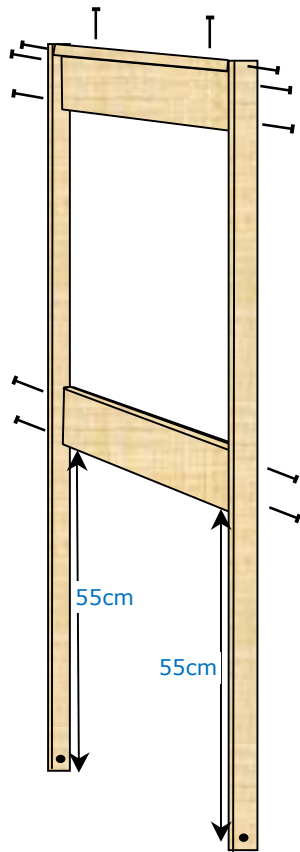

Illustration 18.5

Take the two pieces of aluminium and drill a 6mm hole 10mm in from each end. In one end of each fix a 6mm bolt as shown in illustration 18.6.

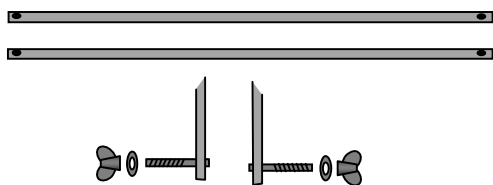

Illustration 18.6

Take the small piece of aluminium or tin, drill a small hole in the centre and shape it as shown in illustration 18.7; this will make it into a cam latch.

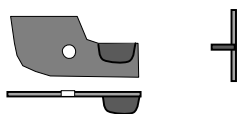

Illustration 18.7

All these parts can now be put together as shown in illustration 18.8. As can be seen the

unit can be open for use or closed for storage and transportation.

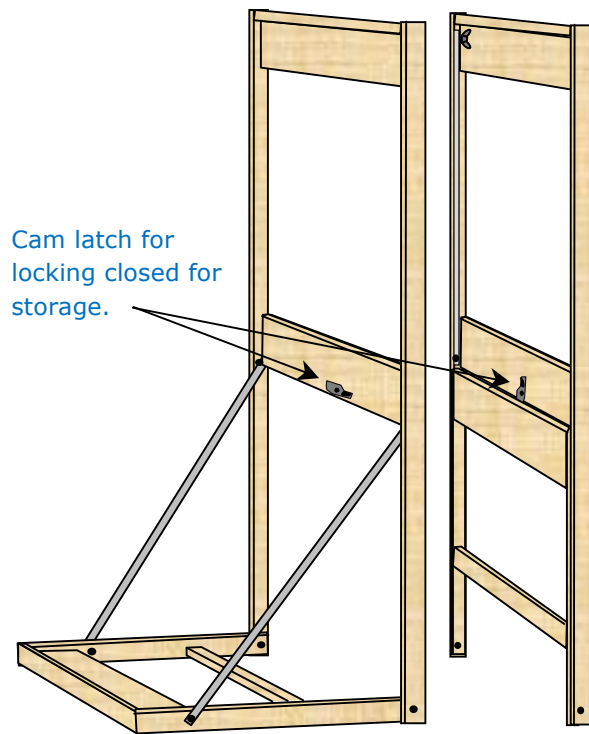

Illustration 18.8

All that is needed now is some dowels to stop the bows sliding together when in use. Cut eight lengths of the 8mm dowel 2cm long. Drill eight 8mm holes 1cm deep evenly spaced across the top of the stand, then using the waterproof wood glue push the dowels into the holes, as shown in illustration 18.9. A small screw can be used to secure both aluminium braces when closed for storage.

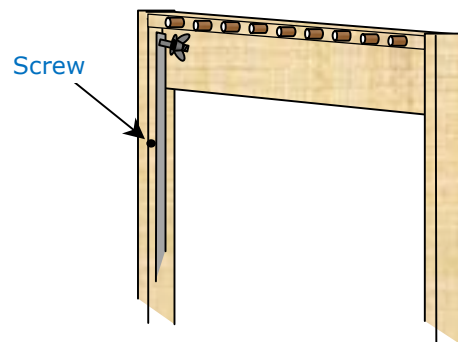

Illustration 18.9

The following illustrations show the bow stand open, closed and in use.



Illustration 18.10
The bow stand open.



Illustration 18.12
The bow stand in use.

~~~~~ o o ~~~~~



Illustration 18.11  
The bow stand closed.

**19. How to make your own arrow container:**

**Materials needed:**

- saw,
- drill,
- drill just larger than the diameter of the arrows,
- rasp or file,
- sand paper,
- panel pins,
- waterproof wood glue
- rule,
- pencil
- plywood - sizes shown below,
- 2 dowels (or similar) 2cm x 50cm.

The sizes may be changed to suit how many arrows you need to accommodate. The sizes shown will accommodate 64 arrows.

The back board should be approximately 60cm long and 21cm wide, illustration 19.1.

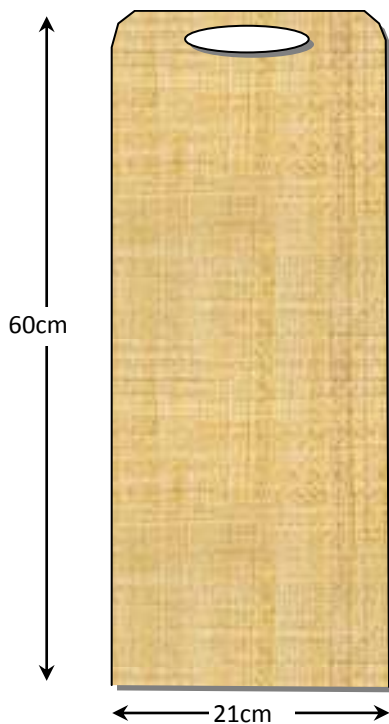

Illustration 19.1

The carrying hole should be large enough so that the hand can be slipped into it and is comfortable when unit is being carried.

The base and the two shelves should be 21cm x 21cm, see illustration 19.2.

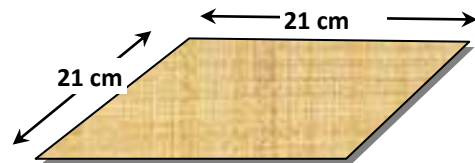

Illustration 19.2

Mark out on the board where the holes should be on one of the shelves, see illustration 19.3.

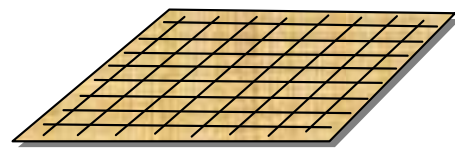

Illustration 19.3

Place this board on top of the other shelf and drill the holes through the two boards, see illustration 19.4.

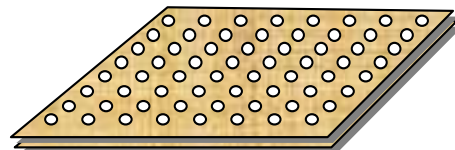

Illustration 19.4

Two strengthening pieces of ply wood are needed; these should be 3 cm wide and 55 cm long. Also, two dowels 2 cm diameter and 50 cm long are required, see illustration 19.5.

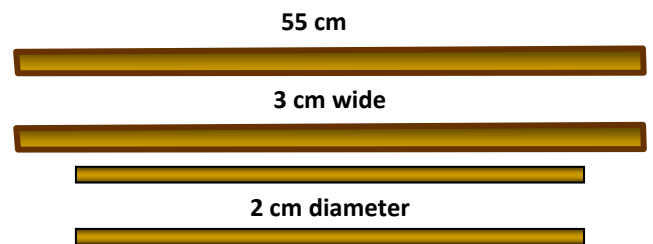

Illustration 19.5

When these parts are ready the assembly can begin. Always use waterproof wood glue and pin the joints with panel pins, see illustration 19.6.

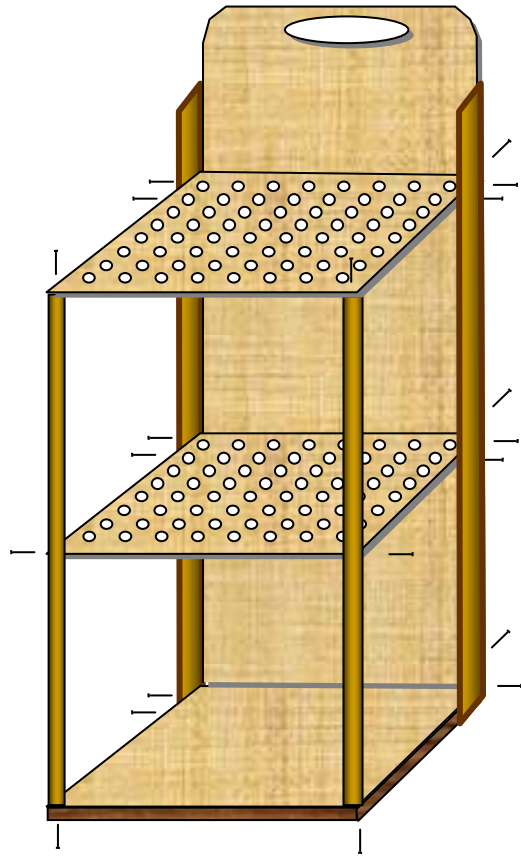

Illustration 19.6

When the unit is completed it should look something similar to that shown in illustration 19.7.



Illustration 19.7

~~~~~ 0 0 ~~~~~